



Bespoke, high quality windows,
doors and conservatories



Edition 2

Taking pride in professionalism and service

www.lockwoodwindows.co.uk

Contents

03:	Introducing the Lockwood Window Company
04:	Composite Doors
05:	Energy and Security - Composite Doors
06-09:	Italia Collection
10:	Beeston
11:	Stafford
12-13:	Ludlow, Harlech & Nottingham
14:	Conway
15:	Tenby
16:	Flint
17:	Windsor
18:	Thornbury
19:	Side Panels and Top Lights
20:	Composite French Doors
21:	Composite Stable Doors
22-23:	Shaped Composite Doors
24:	Bi-fold Doors
25-30:	Our PVCu Windows, Doors & Conservatories
30:	Kommerling
31:	Pilkington KS Glass
32-33:	Energy and Security - Windows
34-39:	Accessories



Introducing The Lockwood Window Company

Established in 1997, The Lockwood Window Company is a long established family business specialising in the design, manufacture and installation of both a bespoke and standard range of PVCu windows, doors and conservatories, and composite doors and windows through sister company **Yorkshire Doors & Windows**.

The team at Lockwood prides itself on the professional and individual level of customer service provided to every customer, which is matched by the highest quality products available. This is reflected in our achievement of a position on the **MWCIA Top 100 Registered** company list.

We are also registered with **FENSA** - the industry standard for replacement windows and doors - so you have complete assurance of our standards. Plus all our products are available with an insurance backed guarantee.

We install into domestic, new build and commercial buildings, and can also offer a 'supply only' service to both members of the public and trade.

All products manufactured by The Lockwood Window Company are CE marked giving you assurance that they comply with all relevant EU legislation.

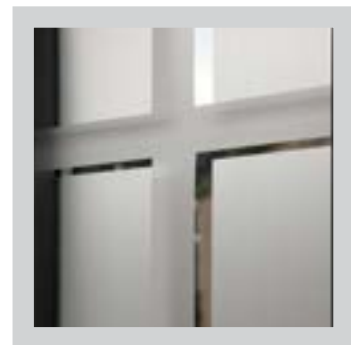
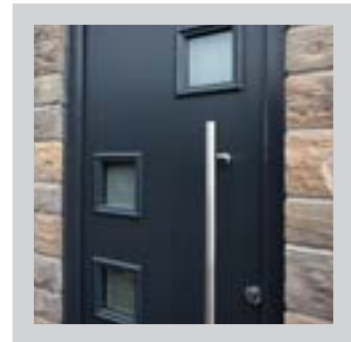

Composite Doors

What is a Composite Door?

The composite doors manufactured by us combine a solid timber core and thermo plastic door skins, with a Kommerling outer frame reinforced with galvanised steel and Astral S locking cylinder. Resulting in a door that is extremely strong and secure.

Although it appears to look just like a solid timber door, a composite door has greater benefits as, thanks to the materials used, it won't fade, discolour or require any maintenance beyond wiping with a damp cloth if it gets dirty.

Below is a comparison between a composite door made by us, and a typical foam filled door to give you an idea of the differences between the two.

Our Construction

Kommerling outer frame reinforced with galvanised steel

Thermally efficient solid hardwood timber core

Robust through colour thermo plastic skins

Realistic wood grain effect or smooth finish

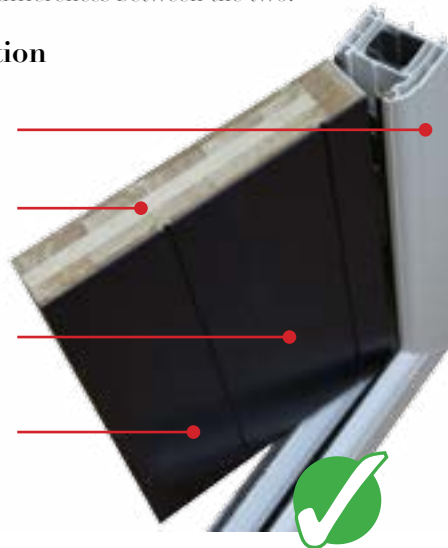

A key point is that our composite doors feature the steel reinforced profile unlike many other companies who just use thermal inserts which are not as strong. Because we manufacture, supply and install to order we can also provide a bespoke service with the ability to create composite doors which incorporate top lights and side panels into the frame. This ensures that your new door is probably the most secure and aesthetically pleasing on the market.

We have a wide range of style, frame and colour options available for your new composite door - whether your preference is traditional, contemporary, French or stable - along with an extensive selection of glass options including a range of obscure glass.

A Typical Foam Filled Construction

Only a small section of the door is actually solid

Thermally good, but foam filled not solid, nor secure.

Gel coated GRP may be strong, but scratches very easily

Most other doors have frames containing lead stabilisers. The frames are only 3 chambers thick

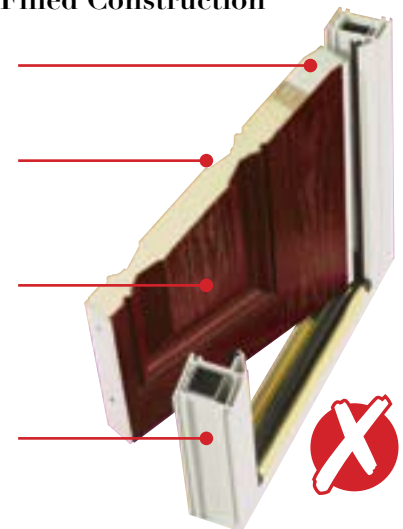

Colour Palette

All composite doors are available in all colour options outlined below.



Glass Options

We have a wide choice of glass available to choose from for your new door, examples of which can be found throughout this brochure. To see all options available for your chosen door, visit our website and use our unique door designer tool.

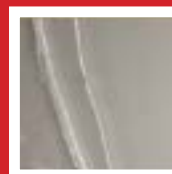

WARWICK GLASS
AVAILABLE IN ALL
OUR DOORS



ABSTRACT GLASS
AVAILABLE IN THE
PISA, TURIN & SIENNA



SATIN GLASS
AVAILABLE IN ALL
OUR DOORS

Energy and Security



All glass fitted in our doors is energy efficient Pilkington KS Glass. This is a low emissivity coated glass which reflects heat back into the room whilst also letting in free heat from the sun, known as passive solar gain. Pilkington KS Glass helps glazed doors to achieve high energy ratings to comply with Building Regulations Part L.

Safe and Secure

With a property burgled every minute in the UK, security of your home is obviously a priority and having a quality front and back door for your home could make all the difference.

A composite door is better than a traditional PVCu or wood door for several reasons. Our 48mm thick solid timber core, pick-resistant multi-point locking systems - the Astral S - and reinforced door frames give you the strongest and most secure option available in a residential door.

The Most Energy Efficient Composite Door

Our range of composite doors are the greenest, most energy efficient and most sustainable composite doors available.

Here's why:

- All of the timber used in the doors are harvested from forests that are managed and are sustainable.
- Each door can be recycled at the end of its life.
- All doors are manufactured in the UK to reduce our carbon footprint.
- The profile of each door has 5 chambers and is completely lead free.
- All doors have lead free skins and edgbanding.



We only use the highest standard of cylinder in our locking systems that have been tested to the highest grade of BS EN 1303 for security, achieving the maximum resistance to physical attack.





THE ITALIA COLLECTION

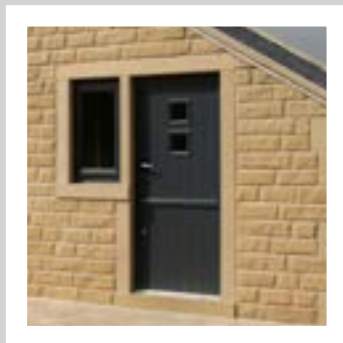

The Italia Collection is a new generation of truly contemporary composite door designs that will add a touch of style to your home. Carefully designed and crafted from the finest materials, every composite door in our Italia Collection has a definite style inspired by the Italian passion for design.

THE ITALIA COLLECTION

All doors in our Italia collection can be made to bespoke requirements with a choice of glass and accessory options. Visit our website to see the full range of options available.



ANCONA SOLID

In Duck Egg Blue with ES 3 door handle, and key only security locking option.



BIELLA

In White with chrome lever handle and multi point locking.



BOLOGNA

In Rosewood with Rosewood frame, ES 24 door handle and key only security locking option.



BRESCIA

In White with ES 3 door handle and key only security locking option.



FLORENCE

In Green with ES 21 door handle and key only security locking option.



GENOA

In Oak with matching frame, chrome handle and multi point locking system.



MESSINA

In Black with Black frame, ES 3 650mm door handle and key only security locking option.



MILANO / PALMA

In Chartwell Green with ES3 handle. Milano - as image
Parma - apertures down centre of door.

THE ITALIA COLLECTION

Outstanding quality; exceptional finish; unsurpassed attention to detail - the ultimate composite door.



MODENA

In Anthracite Grey with ES 24 door handle and key only security locking option.



MONZA

In French Grey with Bistrita glass, chrome finish handle and multi point locking.



NAPLES

In Anthracite Grey with chrome finish handle and bulls eye glass option.



PERUGIA

In Black with Infinity glass, chrome finish handle and multi point locking.



PISA

In Black with Black frame. ES 23 door handle, abstract glass and key only security locking option.



RIMINI

In Anthracite Grey with Waikato glass and key only security locking.



ROMA

In Black with Black frame. ES 21 door handle and key only security locking.



SIENA

In Duck Egg Blue with ES 23 door handle, abstract glass and key only security locking option.

THE ITALIA COLLECTION



SORRENTO

In Cream with ES 3 450mm door handle and key only security locking option.



TURIN

In Cream with Abstract glass, chrome finish handle and multi point locking



VENICE

In Blue with chrome finish handle and multi point locking.

THE ITALIA COLLECTION Glass Options



Infinity Glass



Waikato Glass



Bistrita Glass





Beeston composite door in Flint style in Anthracite Grey.

BEESTON

The traditional style of the Beeston composite door range can be personalised to your taste with a wide selection of glass panel designs. The Beeston is also a popular choice as a stable door for the front or rear of your property.

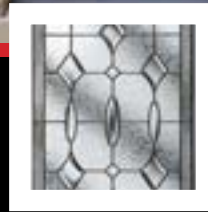

Clarity Glass

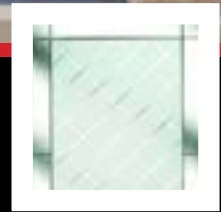

Brilliance Glass



BEESTON 1
In Black with Brilliance glass



BEESTON 1
In Blue with CSB 3.1FG glass



BEESTON 1
In Red with Jewel glass

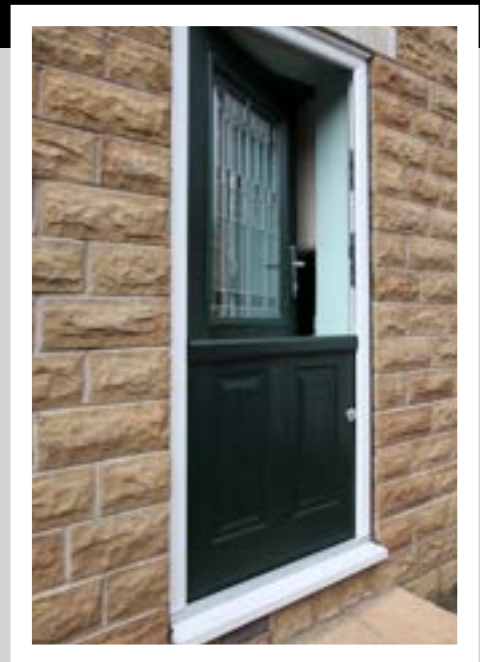

Beeston composite stable door in Green with Prairie glass



STAFFORD

The Stafford range is a stylish alternative for your new or replacement front door with its large, arched glazed panel, available in a selection of fantastic designs.



STAFFORD 1
In Green with
CTL 27.1 glass



STAFFORD 1
In Red with
Diamond Lead glass



STAFFORD 1
In Oak with
CTB 7.1 glass



STAFFORD 1
In Duck Egg Blue with
Quad Blue glass

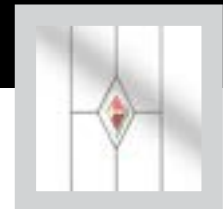

Diamond Red

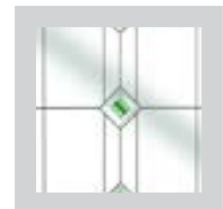

Trio Square Green

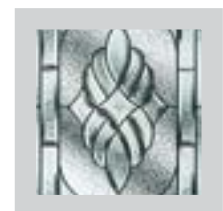

Elegance



Red Ludlow door with Elegance glass

LUDLOW, HARLECH & NOTTINGHAM

The Ludlow is one of the most popular styles of composite door that we offer. Available in all composite door colour options (see p4) with glazed inset panel options.

The Harlech range has a timeless appeal that will enhance any property, in particular those with

gable end features. The solid timber doors feature two glazed inset panels which can be personalised with a choice of designs.

Doors in the unique Nottingham range are ideal for traditional properties as they feature arched glazed panels with a choice of designs.

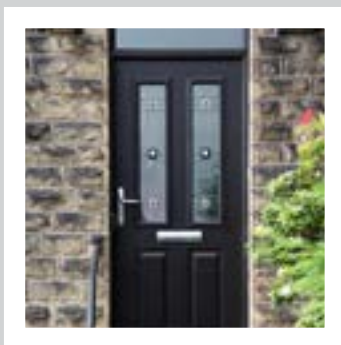

Ludlow 2 composite door and integral top light in Black with CFT 2.2 glass

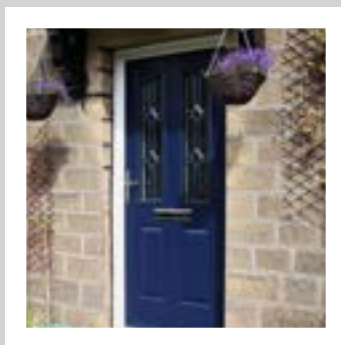

Harlech 2 composite door in Blue with CTB 8.2 glass



Nottingham 2 composite door in Green with bespoke glass

LUDLOW, HARLECH & NOTTINGHAM



LUDLOW 2

In Rosewood with
Brilliant glass

LUDLOW 2

In Black with
CFT 2.2 glass

LUDLOW 2

In Chartwell Green
CTB 19.2 glass

LUDLOW 2

In Duck Egg Blue
with CTB 8.2 glass

**LUDLOW
SOLID**

In Irish Oak

HARLECH 2

In Black with
Jewel glass

HARLECH 2

In Green with
CSB 2.2 glass

HARLECH 2

In Blue with
CTB 8.2 glass



NOTTINGHAM 2

In Black with
Royale glass

NOTTINGHAM 2

In Red with
Quad Black glass

NOTTINGHAM 2

In Rosewood with
Jewel glass

NOTTINGHAM 2

In White with
CTL 20.2 glass

NOTTINGHAM 2

In Green with
CTL 3.2 glass

NOTTINGHAM 2

In Cream with
CTB 19.2 glass

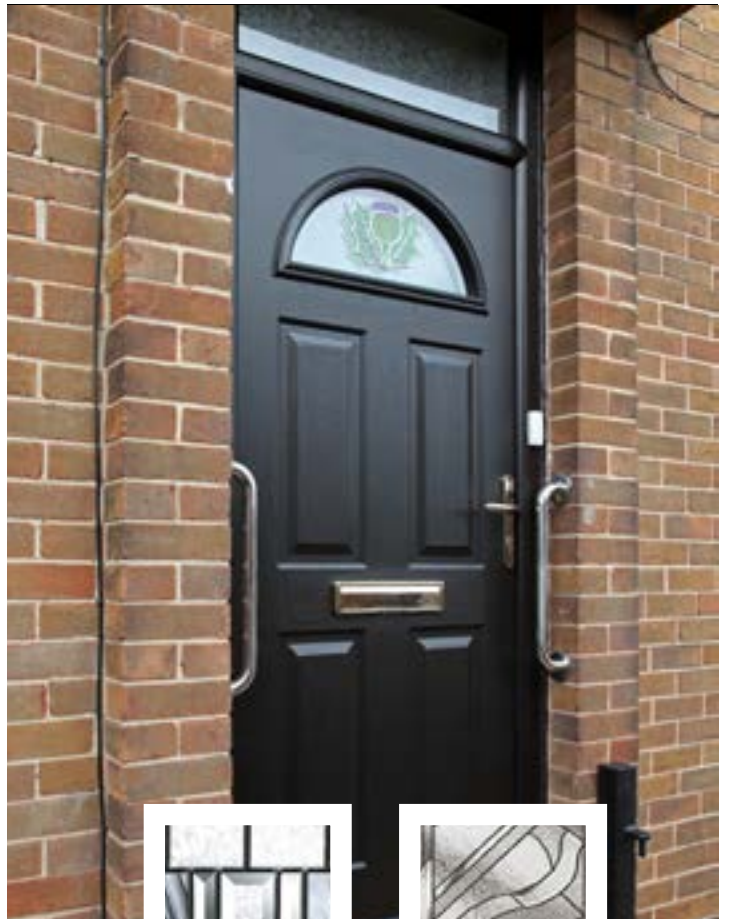

Prairie

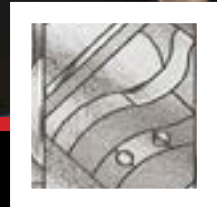

Abstract

CONWAY

The Conway range of composite doors has been designed to complement most properties, whether period or modern, and is available in a choice of colours with glazed panel inset options.



CONWAY 1
In Anthracite Grey
with CSB 5.1FT glass



CONWAY 3
In Black with
Royale glass



CONWAY SOLID
In Irish Oak

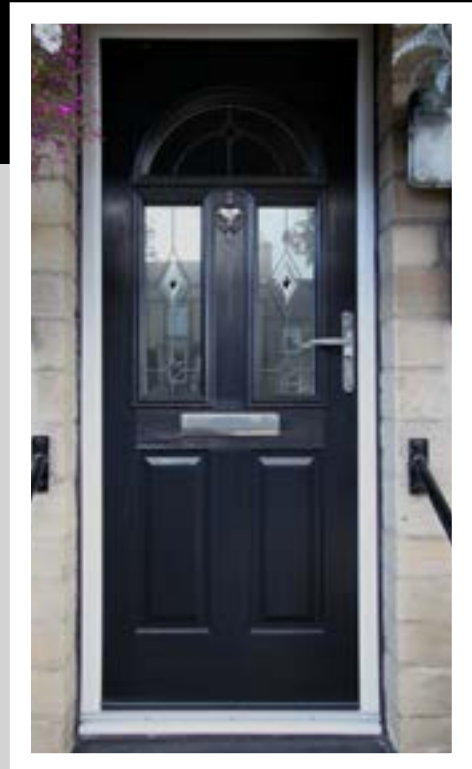

Conway 3 composite door in Black
with Diamond Black glass

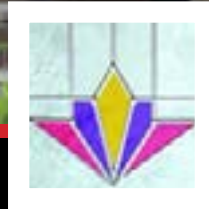

CTL 36.4



CTL 17.4

TENBY

The Tenby range will bring a modern, yet timeless quality to your home. Choose from a great selection of colours and glazed panel designs to complement your home.



TENBY 4
In Blue with
CTL 36.4 glass



TENBY 4
In Anthracite Grey with
Quad Black glass



TENBY SOLID
In Irish Oak



Tenby 2 composite door with top light
incorporated in same frame in Green with
CTL 17.4 glass



FLINT

The Flint range of composite doors was designed with country cottages and farmhouses in mind. It is also a popular option as a side or stable door. Vertical panel styling gives Flint composite doors a traditional look, which can be customised with diamond or rectangular glass features in a range of patterns.



FLINT 1

In Chartwell Green with Bulls Eye glass.



FLINT 2

In White with CTB18 glass.



FLINT 3

In Duck Egg Blue with Quad Blue glass.



FLINT 4

In White with Royale glass.



FLINT 5

In White with Waikato glass.



FLINT SOLID

In Irish Oak



WINDSOR

The Windsor composite door offers a great option for both modern and traditional properties alike. Available as a solid door or with glazing cassette.



WINDSOR
In Duck Egg Blue



WINDSOR
In Chartwell Green



WINDSOR
In Irish Oak



Windsor composite door with glazing cassette

THORBURY

The new Thornbury composite door adds an elegant yet subtle finish to any entrance. Available in our full range of colours.



THORBURY
In Duck Egg Blue

THORBURY
In Cream

THORBURY
In Chartwell Green

THORBURY
In Irish Oak

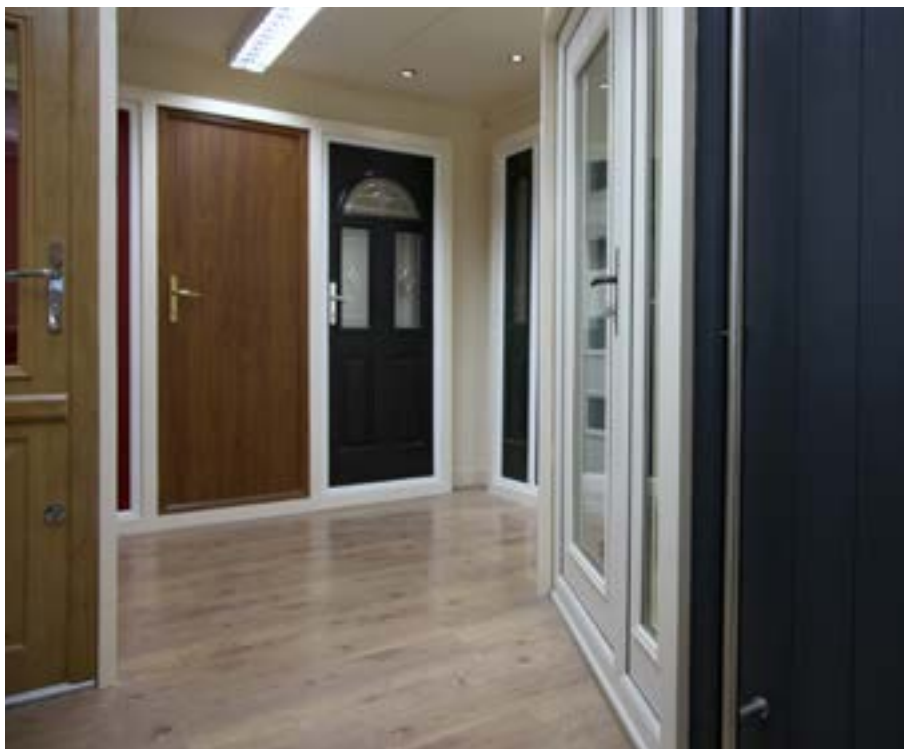

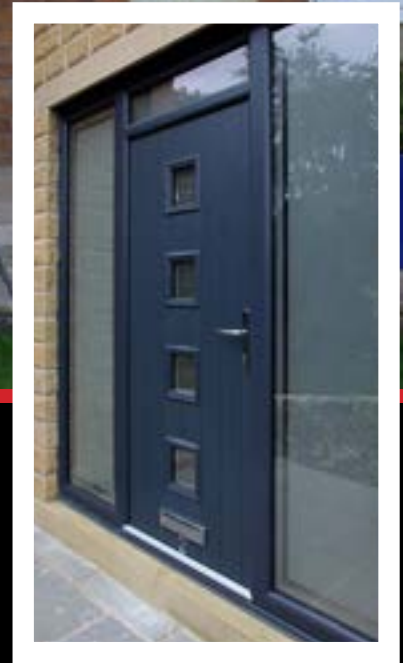

SIDE PANELS AND TOP LIGHTS

Complement your new or replacement composite door with a fully integrated matching full or half height composite side panel, either solid or with glass. Available in any of our colours, inside or out.

We can also manufacture, supply and install top lights to match your chosen composite door design.

All side panels and top lights are fully welded and reinforced, feature the same 48mm thick solid timber core, durable plastic edge banding and 2 thermo plastic skins for security and strength. They are also fitted with energy-efficient Pilkington KS glass.



- | | |
|------------------------------|---------------------------|
| 1 Harlech CTB Side Panel | 6 Milano Side Panel |
| 2 Brescia Side Panel | 7 Infil Quarter Panel |
| 3 Ludlow Abstract Side Panel | 8 Double Infil Half Panel |
| 4 Tenby Side Panel | |
| 5 Nottingham Side Panel | |



COMPOSITE FRENCH DOORS

Although previously only available in PVCu, you can now take advantage of all the fantastic benefits of a composite door in a French door style. What's more you can choose any of our existing composite doors designs to be made into French doors for your home, and with the same choice of beautiful colourways inside and out. All our doors are also available with either an outward or inward opening option.



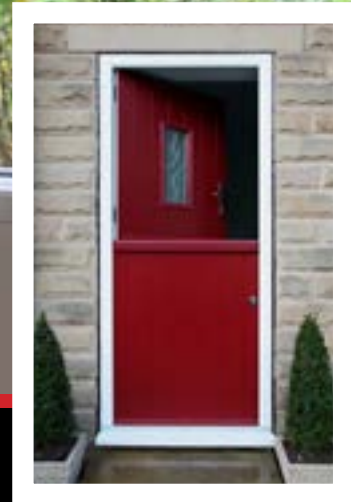

STABLE DOORS

A composite stable door can add a whole new dimension to your kitchen or back door, with all the benefits of a PVCu door and none of the ongoing maintenance issues of a timber stable door.



Our stable doors can be opened either inwards or outwards, and are available in any of our colours, inside or out, and the majority of our styles (excluding some Italia designs - ask for details).

We can also manufacture composite stable doors to any size like this one (pictured right) which is just 1740mm x 940mm!

As standard, all our stable doors come with a high security, fully adjustable multi point locking system. They are also keyed alike and benefit from an internal thumb turn cylinder on the bottom half (optional). They also have a latching security bolt as standard.

We also have an extensive range of traditional and contemporary ironmongery to add the finishing touch to your new stable door, including door knockers, door handles and letter plates. (See accessories page).





SHAPED COMPOSITE DOORS

Under normal circumstances if you had a shaped door entrance you would not be able to have a composite door, as it has not been possible to shape the door slab due to the nature of the material.

However, because we have extensive knowledge of the industry, we have invested in research and development in order to be able to overcome this difficulty and provide you with a truly bespoke service that allows you to have a composite door - whatever shape you require. Available either opening inwards or outwards.



Bespoke Roma composite door in White with integrated side panels.

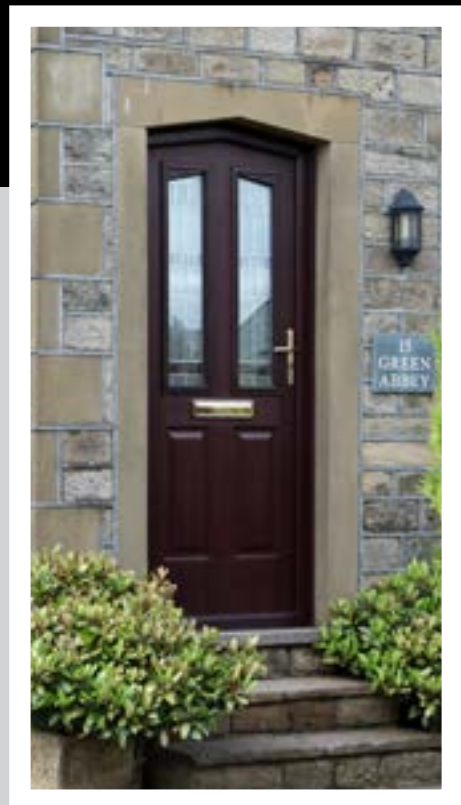

Shaped Harlech composite door in Rosewood with Prairie glass

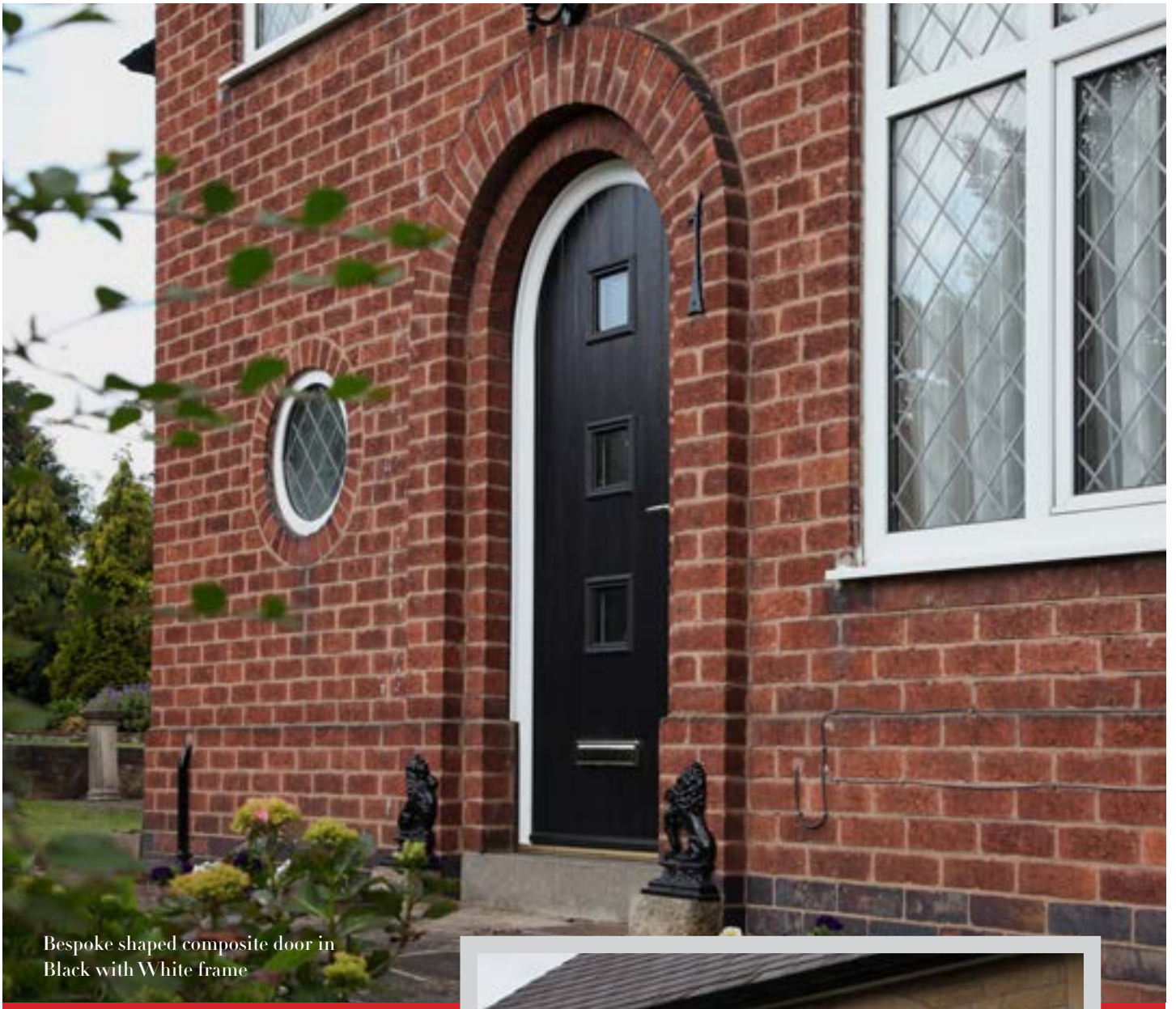

Bespoke shaped composite door in Black with White frame



Arched Beeston composite door in White with clear glass and integrated side panels.



Shaped Flint 2 composite door in Rosewood



BI-FOLD DOORS

Bi-fold doors are the ideal solution to let in light and bring the outside in, either extending your living room into your garden or bedroom to balcony.

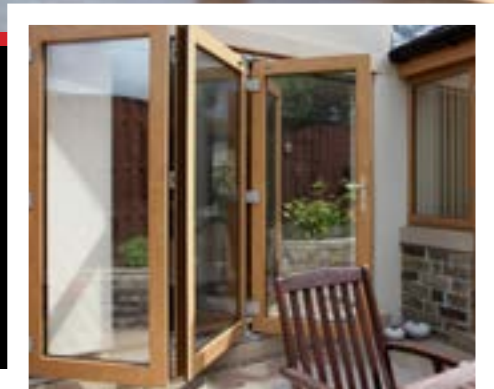

PVCu

Our PVCu bi-fold doors use the new and improved Kommerling frame, which can be made to match doors and windows, and provides a unique combination of either a classic or modern appearance with state-of-the-art performance. They are also 5 chambered for better thermal efficiency.

Aluminium

Alternatively you could choose the more slimline aluminium option for your bi-fold doors, which can be manufactured to replace entire walls to expand your living space, and have narrow sight lines to allow maximum light to flood into a room.

Pilkington KS Glass is also fitted as standard to all our bi-fold doors which helps to achieve high energy ratings as it is a low emissivity coated glass that reflects heat back into the room whilst also letting in free heat from the sun.

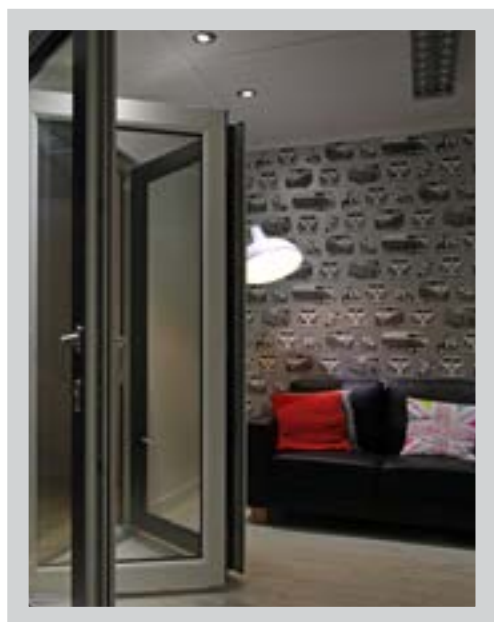



PVCu WINDOWS, DOORS & CONSERVATORIES

Whether you are looking for double-glazing, PVCu windows and doors or conservatories, Lockwood Windows can fulfil all your requirements.

All our products are available in a choice of foil-laminated colours, which are durable, hard-wearing and weather resistant. (Dual and additional colours are available on request.)

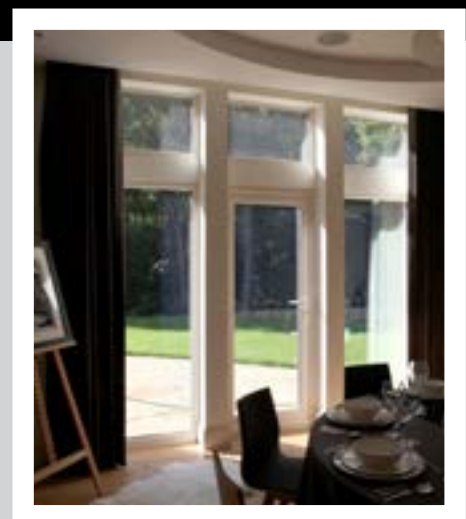

COLOURS AVAILABLE

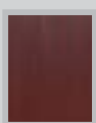

ROSEWOOD



FOILED
WHITE



WHITE

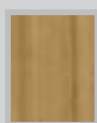

IRISH OAK



OAK



ANTHRACITE
GREY

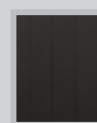

BLACK

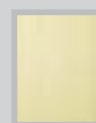

CREAM

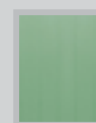

CHARTWELL
GREEN

PVCu WINDOWS



We are able to manufacture an extensive range of window styles including patio (with tilt and slide option), casement, sash (with sash horns), and tilt and turn with concealed locking mechanisms.

Our coloured window frames are also available with coloured interior trims to complement the frames, and are also manufactured with internal beading as standard.

Roofline fascias, soffit boards and cladding is also available to match windows.

Please visit our website for more details.

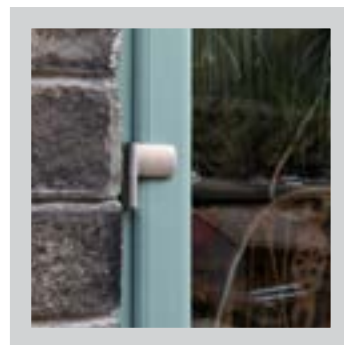
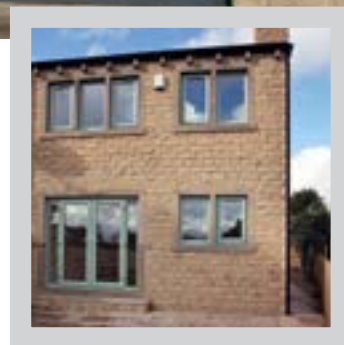

PVCu DOORS



In addition to our extensive range of windows, we also manufacture a wide selection of door styles including residential front doors, patio doors, French doors, bi-fold doors (see p24), and stable doors, which are all fully reinforced with galvanised steel.

All normal residential doors are fitted with high security, state of the art locking mechanisms and handles as standard, including shoot bolts and hooks to top and bottom, dead bolts with latch and four rollers for compression.

Security cylinders are fitted to all doors as standard and have been since November 2005.

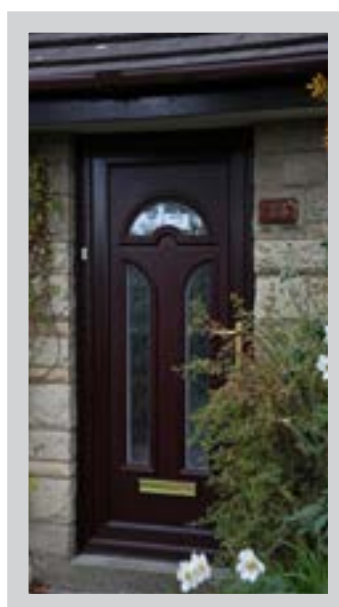

PVCu FRENCH DOORS



Our PVCu French doors are available in a choice of colours, both inside and out, and are the perfect addition to your home - helping to bring the outside in, with unrestricted access to your garden, patio or conservatory.

Energy efficient, high quality and secure, our French doors are internally beaded and have a multi-point locking system as standard.

Whether you choose to have your new doors opening inwards or outwards, they will come with a standard set of handles, or you can select an alternative from our accessory range (additional cost may apply).

PVCu CONSERVATORIES



We have vast experience in designing and installing conservatories of all types, both traditional and contemporary.

Glass and polycarbonate are the two types of conservatory roof materials available, both having different colours and various heat guarding foils to help to regulate the temperature, and reduce the solar glare inside the conservatory.

Each conservatory is designed to your specification, so whatever style and finish you choose we will use our experience and knowledge to bring you the best solution at a realistic price.

We also employ our own builders, electricians and plumbers to make your new project as hassle free as possible.



White Conservatory with sunburst design and polycarbonate roof



White PVC Conservatory with self cleaning roof



KOMMERLING

We manufacture using the Kommerling 070 Gold or C70 PVCu systems as we believe they are the best products available on the market.

070 Gold:

- 5-chambered with revolutionary ovolo or rounded profile providing a unique combination of classic appearance and state-of-the-art performance.
- Curved slimline frame and opening sash create a 'softer' appearance whilst offering unrivalled benefits.
- Steel reinforced profiles.
- High security multi-point locking and shoot bolts.
- Extruded using a lead-free PVCu Greenline compound.
- Fitted with Pilkington KS glass.
- Meet or exceed Level C on Energy Rating Certificate in accordance with latest Building Regulations.

C70:

- Has the same properties as 070 Gold but gives a more modern look and feel with clean lines without compromising thermal efficiency or security.

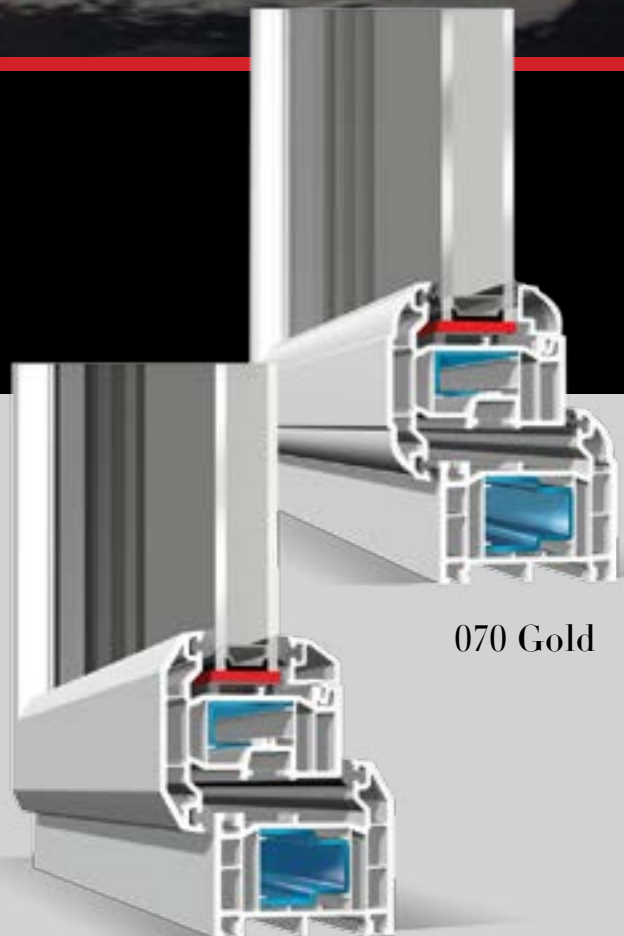

070 Gold

C70



KÖMMERLING®



PILKINGTON KS GLASS

Since 2002 all new and replacement glazed doors or windows have to use Pilkington KS Glass or similar low 'e' glass. This is a low emissivity coated glass which reflects heat back into the room whilst also letting in free heat from the sun, known as passive solar gain. Pilkington KS Glass helps windows and doors to achieve high energy ratings to comply with Building Regulations Part L.

PILKINGTON ENERGIKARE

Also available is Pilkington energiKare. This is an energy efficient double glazing unit from Pilkington. When installed in good window frames it helps to achieve the requirements of the Energy Saving Trust, which has resulted in the glass receiving Energy Saving Recommended status as an energy efficient product.

All windows and doors are fitted with high quality handles, and high security, state of the art locking mechanisms.

Upgrades are offered on ironmongery to complement each customers individual taste.
See p34 - 39 for details.



PILKINGTON TEXTURE GLASS WARWICK

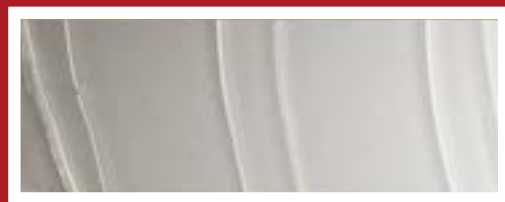

This design is unique amongst our patterns because it is produced using a different manufacturing method. Pilkington Texture Glass Warwick is a random pattern that is added along the central portion of the pane and this has implications when cutting the glass down into finished sizes.

It is possible, if a pane is cut small enough, it could be cut with no evidence of the pattern at all.

None of the Pilkington patterns are designed to have an orientation (an up side) but care needs to be taken with adjacent panes that the pattern direction is maintained.

There is a linear nature to Pilkington Texture Glass Warwick and so householders should be aware that there could be aesthetic implications when choosing this design. Also, for the glass supplier the result may be that this pattern is less accommodating of seldge from the original glass plate.

ENERGY AND SECURITY

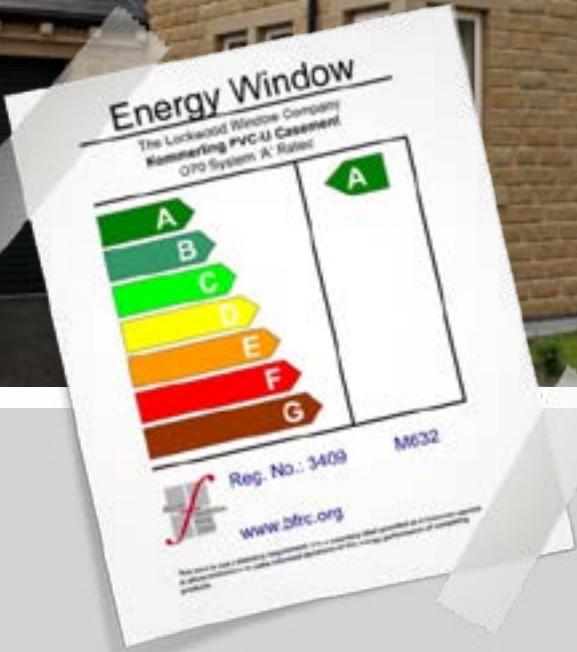

Windows which are installed must be compliant with building regulations in regards to thermal loss, as all homes now need to be as energy efficient as possible.

The British Fenestration Rating Council (BFRC), in conjunction with the UK glazing industry and European partners, has designed a window rating system which provides simple and accurate information regarding the energy efficiency of a product.

All windows supplied and / or installed by Lockwood Windows are A-rated as standard.

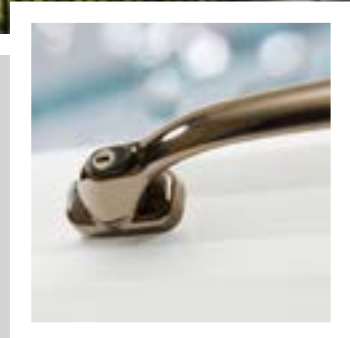

The BFRC provides third party certification for the total thermal performance of windows, which are rated using the familiar A to G scale on the basis of their total energy efficiency, where A-rated is more energy efficient than G-rated.

This means that you can quickly choose the most suitable window for your needs, and government inspectors and agencies can quickly see if the window meets the legal requirements.

In order to achieve a C-rated window, or above, many companies are choosing to use a basic PVCu system, which achieves the required efficiency rating but is sadly lacking when it comes to security, with only a thermal plastic sleeve for reinforcement, or no reinforcement at all.

For this reason, we advise customers to think carefully before deciding which company to use for new or replacement windows, and would recommend that you ask some key questions before proceeding.

1 Is your supplier part of the BFRC authorised retailer scheme or a member of FENSA? This provides you of assurances of their professionalism and standards.

2 Does the supplier use the A-E energy-efficiency rating? This will help you make a more informed choice as to which windows you choose.

3 Do the frames of your new windows have integral metal reinforcement to maximise security? Window frames without this will not be as secure.

4 Is your supplier listed in the Master Window and Conservatory Installers Association's Top 100 list?

At Lockwood Windows we are not prepared to compromise on security or quality, and have invested heavily to provide the most energy efficient and secure window systems available on the market today.





ACCESSORIES

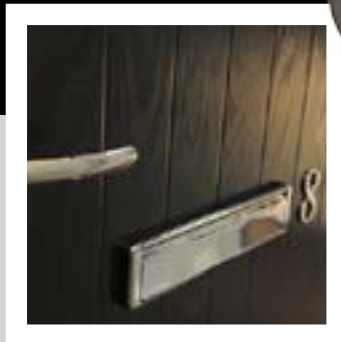
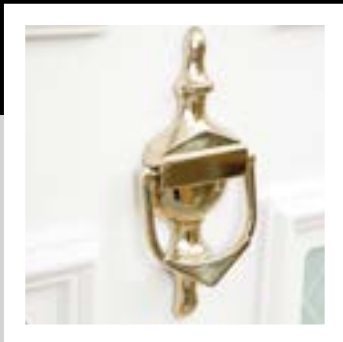

We offer an extensive selection of accessories and ironmongery to complement whichever composite door or PVCu door, windows or conservatory you choose. From knockers and handles to letter plates, we have both traditional and contemporary options for you to choose from.

- 1 Victorian Urn - Hardex - Bronze
- 2 Horsetail Knocker - Chrome
- 3 Door Hinge (PVC Only)
- 4 Letterplate - Hardex - Gold



DOOR KNOCKERS

- 5 Victorian Urn - HG
- 6 Victorian Urn - SI
- 7 Victorian Urn - SAT
- 8 Victorian Urn - HB
- 9 Victorian Urn - GR
- 10 Victorian Urn - HS
- 11 Victorian Urn - WH
- 12 Victorian Urn - HC
- 13 Victorian Urn - BL
- 14 Victorian Urn - AV
- 15 Victorian Urn Spyhole - HG
- 16 Victorian Urn Spyhole - SAT
- 17 Victorian Urn Spyhole - HB
- 18 Victorian Urn Spyhole - SI
- 19 Victorian Urn Spyhole - HS
- 20 Victorian Urn Spyhole - WH
- 21 Victorian Urn Spyhole - HC
- 22 Victorian Urn Spyhole - BL
- 23 Victorian Urn Spyhole - AV

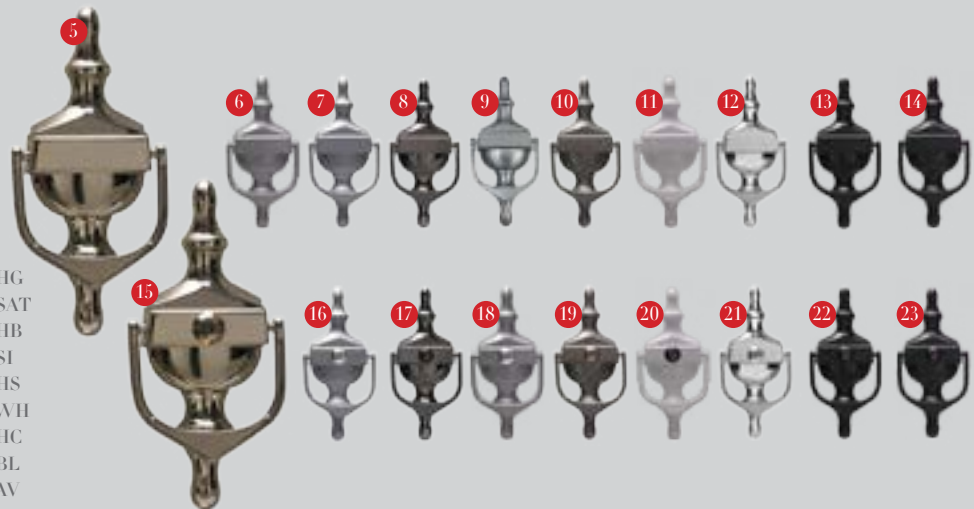

- 24 Slim Knocker - HB
- 25 Slim Knocker - WH
- 26 Slim Knocker - SI
- 27 Slim Knocker - SAT
- 28 Slim Knocker - HS
- 29 Slim Knocker - HG
- 30 Slim Knocker - HC
- 31 Slim Knocker - AV
- 32 Slim Knocker - BL
- 33 Slim Knocker Spyhole - HB
- 34 Slim Knocker Spyhole - WH
- 35 Slim Knocker Spyhole - SI
- 36 Slim Knocker Spyhole - SAT
- 37 Slim Knocker Spyhole - HS
- 38 Slim Knocker Spyhole - HG
- 39 Slim Knocker Spyhole - HC
- 40 Slim Knocker Spyhole - AV
- 41 Slim Knocker Spyhole - BL





DOOR KNOCKERS

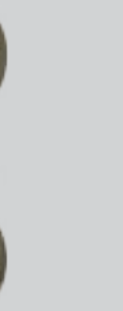
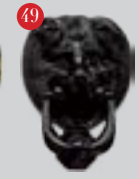

- 42 Lions Head Knocker - HS
- 43 Lions Head Knocker - HC
- 44 Lions Head Knocker - HB
- 45 Lions Head Knocker - AB
- 46 Lions Head Knocker - WH
- 47 Lions Head Knocker - SAT
- 48 Lions Head Knocker - HG
- 49 Lions Head Knocker - BL
- 50 Horsetail Knocker - HS
- 51 Horsetail Knocker - AV
- 52 Horsetail Knocker - WH
- 53 Horsetail Knocker - SI
- 54 Horsetail Knocker - HC
- 55 Horsetail Knocker - HB
- 56 Horsetail Knocker - BL
- 57 Horsetail Knocker - AB
- 58 Horsetail Knocker - HG
- 59 Contemporary Knocker - HG
- 60 Contemporary Knocker - WH
- 61 Contemporary Knocker - HC
- 62 Hand Made Pewter Ring
- 63 Hand Made Black Ring



DOOR HANDLES

- 64 ES24 Pull Handle
- 65 EK53 Pull Handle
- 66 EK350 Pull Handle
- 67 Inline Handle - 80
- 68 Inline Handle - 100
- 69 Inline Handle - 120
- 70 Inline Handle - 140
- 71 Inline Handle - 160
- 72 Inline Handle - 180
- 73 D Handle
- 74 Lever Handle - HS
- 75 Lever Handle - HG
- 76 Lever Handle - HC
- 77 Lever Handle - BL
- 78 Lever Handle - AB
- 79 Lever Handle - WH
- 80 Lever Handle - SI
- 81 Lever Handle - HB
- 82 Windsor Handle - WH
- 83 Windsor Handle - SI
- 84 Windsor Handle - HC
- 85 Windsor Handle - HB
- 86 Windsor Handle - AB
- 87 Windsor Handle - HS
- 88 Windsor Handle - HG
- 89 Windsor Handle - BL

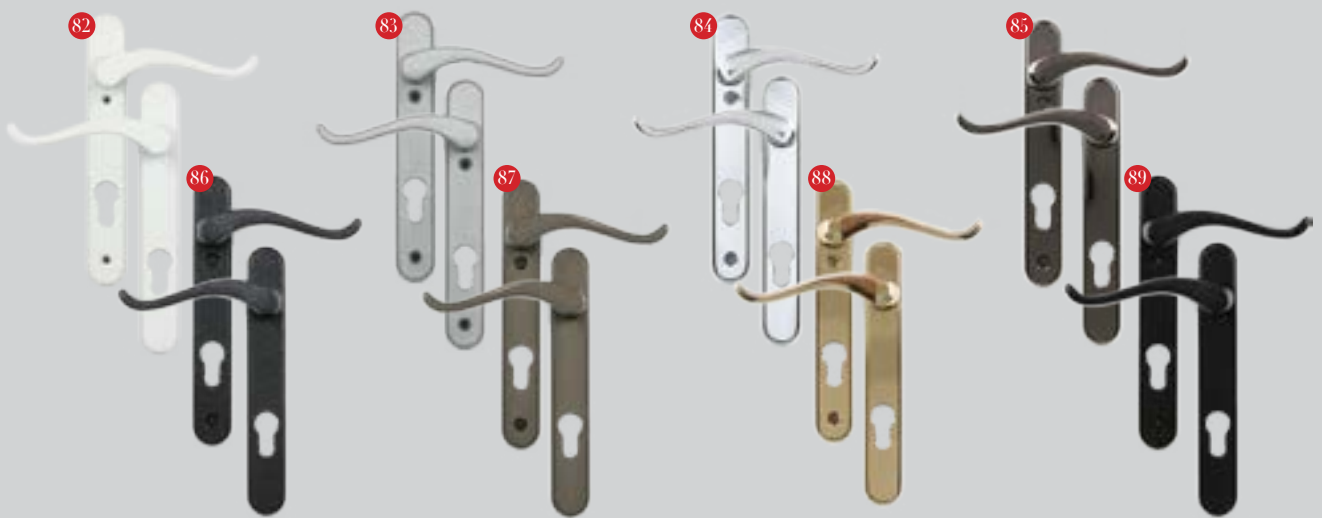
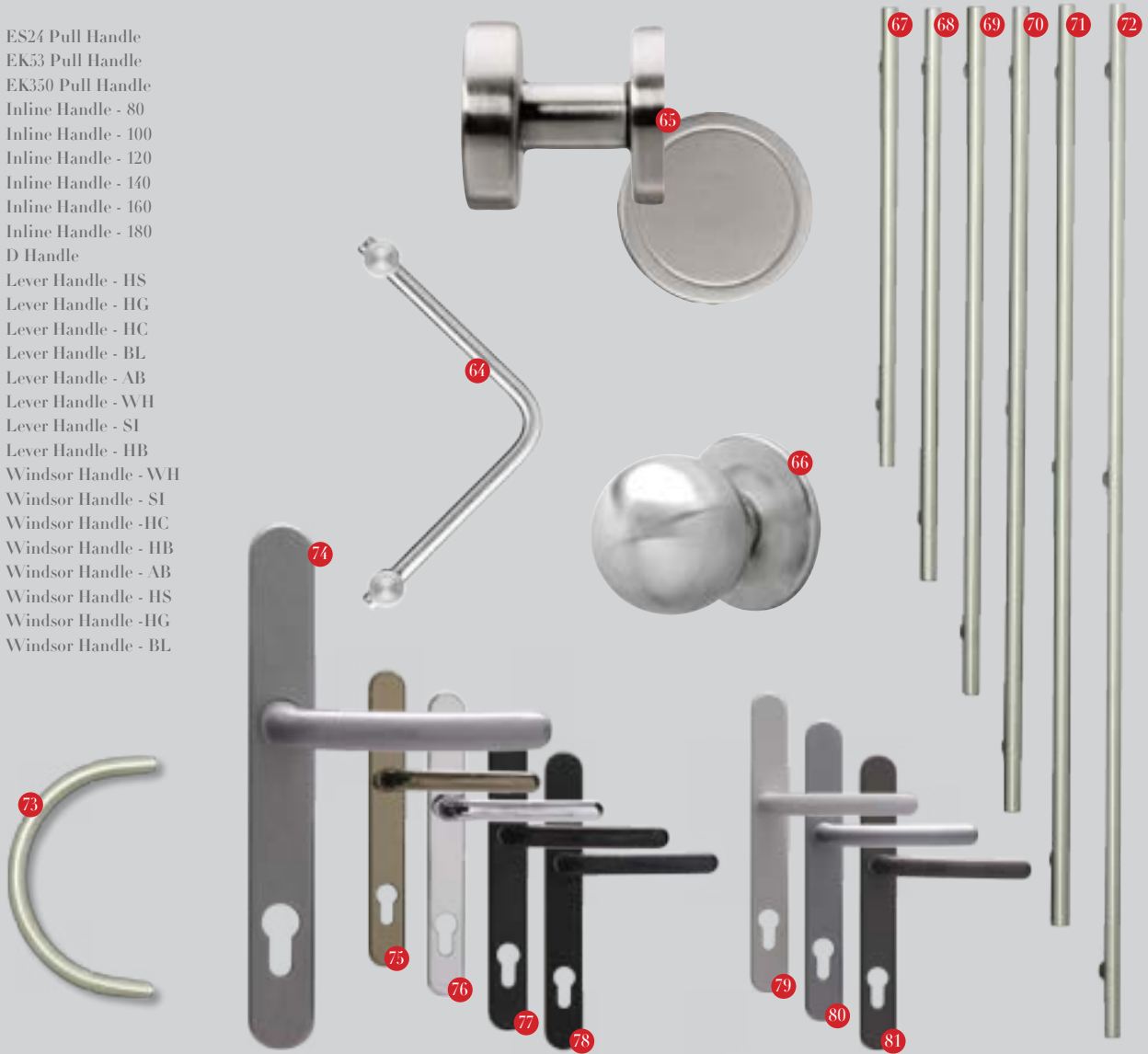



90



91

DOOR GUARDS / THUMB TURN WINDOW HANDLES

- 90 Thumb Turn Cylinder
- 91 Monkey Tail Handle - HG
- 92 Door Guard - Chrome
- 93 Door Guard - Gold
- 94 Monkey Tail Handle - AB
- Also available in:
- Black*
- Chrome*
- Gold*
- Graphite*
- 95 Inline Handle - WH
- 96 Inline Handle - BL
- 97 Inline Handle - HB
- 98 Inline Handle - SI
- 99 Inline Handle - HC
- 100 Inline Handle - AB
- 101 Inline Handle - HG
- 102 Inline Handle - HS





DOOR NUMBERS, HINGES, LETTERPLATES & WALL MOUNTED LETTERPLATES

- 103 Numail Letterplate - GR
- 104 Numail Letterplate - AB
- 105 Numail Letterplate - BL
- 106 Numail Letterplate - WH
- 107 Numail Letterplate - SI
- 108 Numail Letterplate - SS
- 109 Numail Letterplate - HS
- 110 Numail Letterplate - SAT
- 111 Numail Letterplate - HG
- 112 Numail Letterplate - HC
- 113 Numail Letterplate - HB
- 114 Number - S
- 115 Number - WH
- 116 Number - HG
- 117 Door Hinge - HS - PVC Only
- 118 Door Hinge - HC - PVC Only
- 119 Door Hinge - SAT - PVC Only
- 120 EBK10 Wall Mounted Letterbox - Stainless Steel
- 121 EBK13 Wall Mounted Letterbox - Stainless Steel

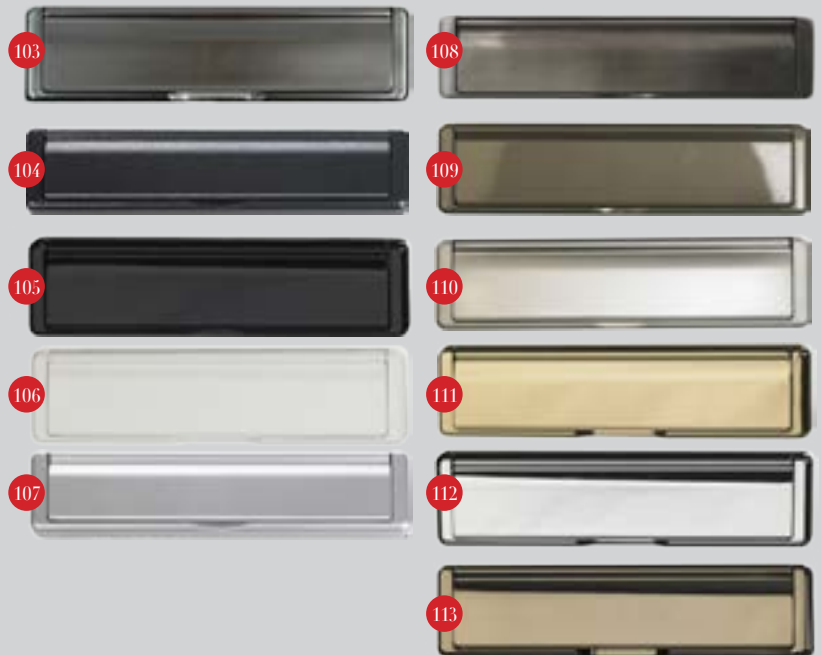

Opening Hours

Mon - Thurs 8:00am - 5:00pm

Fri 8:00am - 4:30pm

Sat 9:00am - 12:00 noon

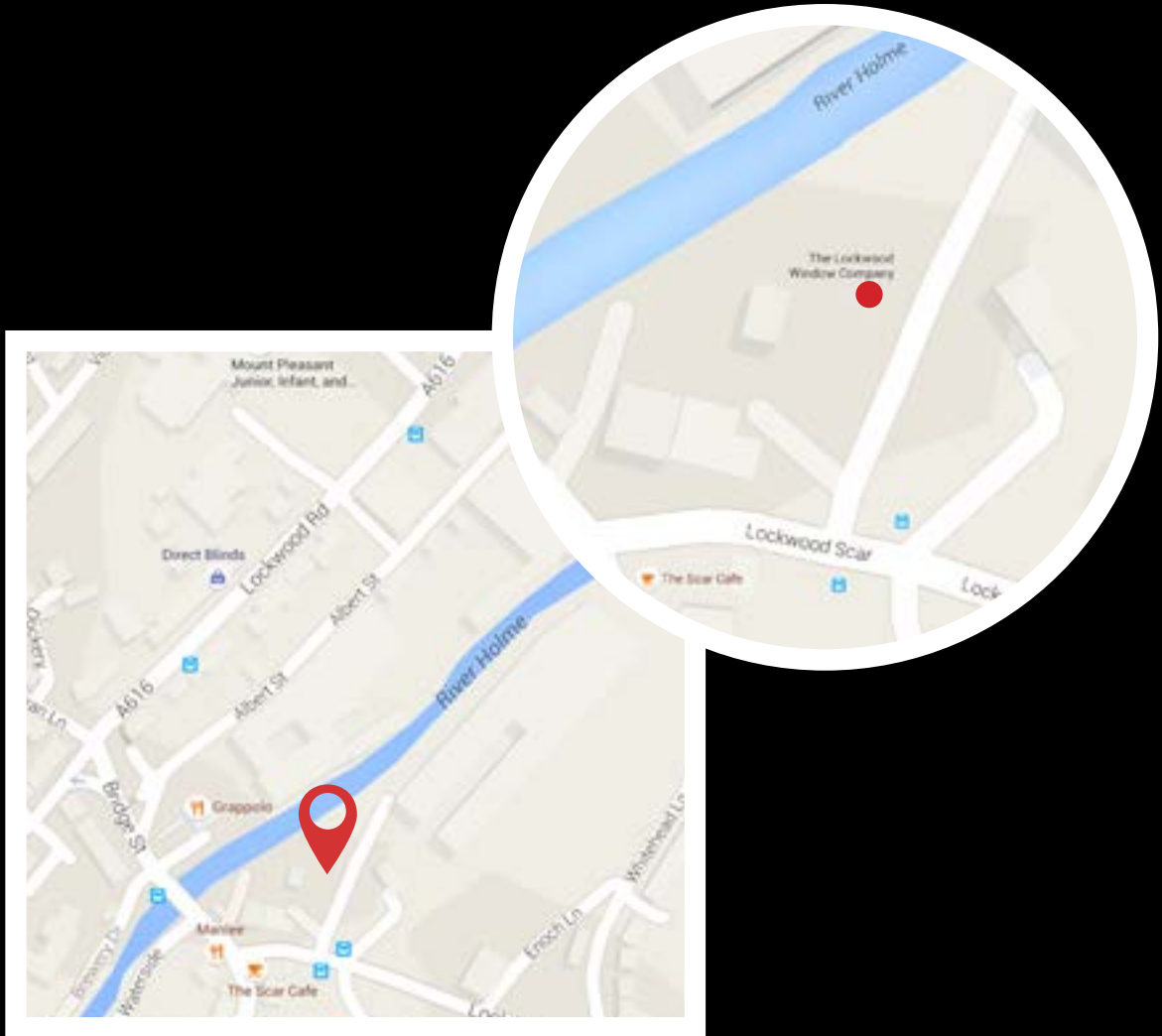

The Lockwood Window Co. Ltd

Unit 4 - Perseverance Mills, Lockwood Scar,
Huddersfield, West Yorkshire. HD4 6BW

T: 01484 519677 F: 01484 519676

E: info@lockwoodwindows.co.uk

W: www.lockwoodwindows.co.uk



Yorkshire Doors & Windows

Yorkshire Doors & Windows

Unit 4 - Perseverance Mills, Lockwood Scar,
Huddersfield, West Yorkshire. HD4 6BW

T: 01484 544571 F: 01484 519676

E: info@lockwoodwindows.co.uk

W: www.yorkshiredoorsandwindows.co.uk

